



VERTIV™

Liebert®

**XD™- HIGH DENSITY
MODULAR COOLING**

Flexible, Energy-Saving Cooling Solutions
For High Heat Density Applications



Liebert® XD™ Saves Significant Energy

Today, more than ever, environmental and economic issues are pushing business continuity professionals to lobby for energy efficient, environmentally friendly solutions in their data centers. The Liebert XD solution is the answer on both fronts.

The Liebert XD system can reduce the data center's air conditioning energy consumption by 30% when utilized as a supplemental cooling and up to 70% when deployed as the primary cooling. Implementing the Liebert XD solution requires 15%-50% less chiller plant capacity as well as less diesel generator and switch gear capacity resulting in a potential energy savings of 40-50% for your centers energy consumption.

- Locating cooling units closer to the load reduces the energy required to move the air and results in less mixing of hot and cold air
- Micro channel coils provide minimal air pressure drop losses and improved thermal heat transfer
- No need to over-chill data centers to eliminate hot spots

However, flexibility is also an important attribute of your cooling systems. The Liebert XD solution allows your facility to adapt as heat loads increase. And by adding/reconfiguring solutions to react to changes in your environment, the flexible configuration of the Liebert XD system modules also allows scalability for future growth.

Energy Usage

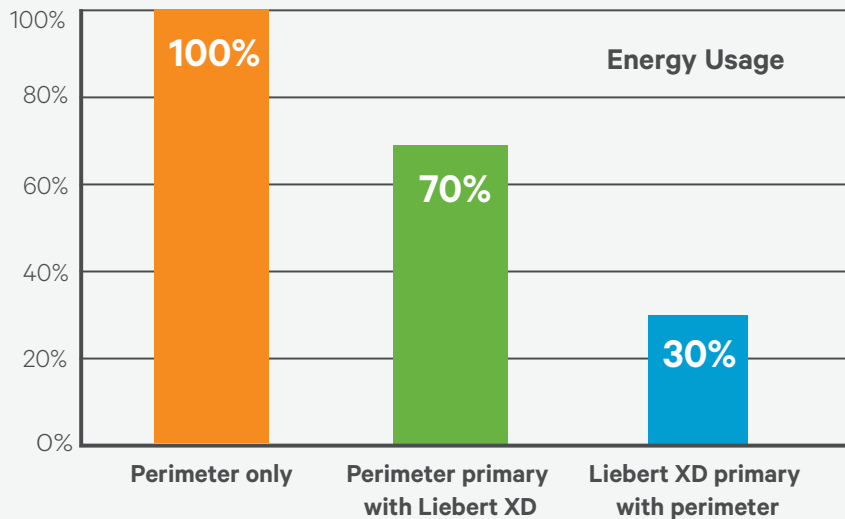

The traditional deployment of the Liebert XD system is as a supplemental cooling solution, which can save ~30% of the energy to cool the data center. Some Liebert XD modules can save up to 50% of energy. The chart at the left shows the Liebert CW181 alone; Liebert CW 181 primary with paired with a Liebert XDP and Liebert XD Smart Modules; and the Liebert XD system as the primary cooling, with Liebert CW181 providing supplementary cooling. By using the Liebert XD system as the primary cooling, the datacenter can save approximately 70% in energy.

BENEFITS

Lowest Total Cost of Ownership

- Total energy savings potential of up to 70%
- More cost-effective than increasing room cooling capacity using floor-mounted cooling units only
- Minimal floor space requirements

Flexibility

- Floor-mount, rack-mount, and ceiling-mount modules, plus a choice of cooling capacities
- Plug and play installation for future growth
- Can cool more than 30 kW per rack
- Efficiently draws hot air out of equipment racks and moves cool air into the cold aisle

Availability

- Uses pumped refrigerant as the cooling fluid - safer for use around electronic equipment
- Complete packaged systems ensure fast and reliable installation

Liebert® XD™ Solutions Cut Capital Costs

Investing in a facility that utilizes a higher rack density design — along with a cooling system designed especially for this type of installation — offers a significant cost savings advantage in terms of building size and energy usage.

The flexible configuration of the Liebert XD system modules also allows scalability for future growth, as well as the ability to efficiently add redundant units for maximum reliability in the most mission-critical applications. The Liebert XD approach significantly improves floor space utilization compared to an installation using only —floor-mounted cooling units. Because of the variety of cooling module sizes and placement, installing more Liebert XD capacity uses little or no additional floor area.

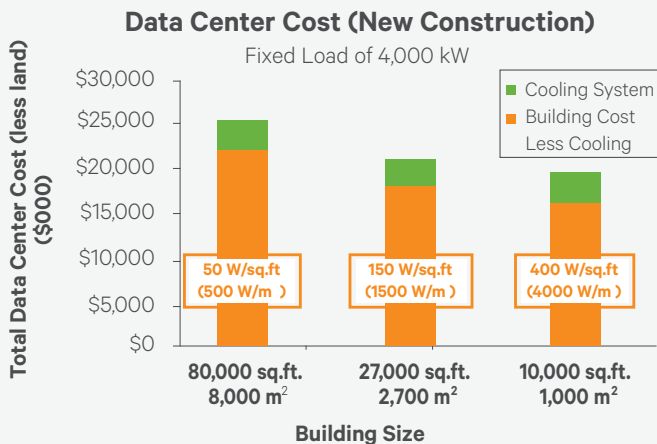

The capital costs of a data center are significantly reduced as higher densities of IT equipment are housed in smaller sized areas.

Study — Data Center Cost (New Construction) 400 racks with an average heat load of 10 kW each. Cost for building, power, cooling, lighting, fire protection, security, etc. included. Cost of land not included.

Building 1: 80,000 sq.ft. (8000m²), 18" (450mm) Raised Floor, Designed for 50 W/sq.ft (500W/m²), Raised-floor Precision Air Conditioning units for cooling.

Building 2: 27,000 sq.ft. (2700m²), 36" (900mm) Raised Floor. Designed for 150 W/sq.ft (1500W/m²), Raised-floor Precision Air Conditioning units for cooling.

Building 3: 10,000 sq.ft. (1000m²), 18" (450mm) Raised Floor. Designed for 400 W/sq.ft (4000W/m²), Raised-floor Precision Air Conditioning units (for basic cooling and humidity control) and Liebert XD.

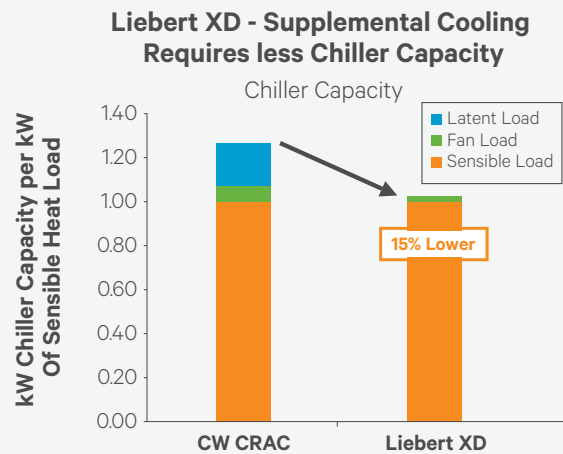

One of the major areas of savings identified with the use of Liebert XD equipment is the fact that the chiller plant size can be reduced. This is because the chiller typically is sized for the total gross capacity of the raised-floor cooling units. The 65% lower fan load of the Liebert XD System modules and the fact they are 100% sensible easily results in a capital chiller size savings of 15% or more.

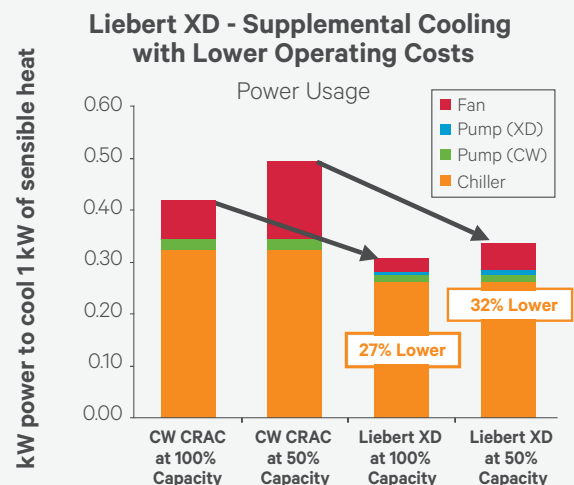

The smaller chiller plant and lower fan load result in significant energy savings as well. A 27% energy savings is very conservative.

High Heat Density. High Temperatures.

Today's data center technologies compound conventional cooling problems. Blade servers, communications switches and other electronics are being packed into tighter and tighter spaces. Computing capacity that once filled an entire room is now contained in a single rack — creating extreme power and heat densities.

Conventional Solutions Just Can't Keep Up

While the cornerstone of an effective cooling strategy, you can't rely solely on conventional mission-critical cooling systems to resolve such high heat densities. Hot spots or zones require targeted cooling solutions. And, for extremely high heat loads, conventional approaches may simply take up too much floor space to be practical.

Business continuity professionals will rely on an integrated solution — one that solves both room-level and rack-level cooling challenges.

Higher Watt, Higher Heat Densities

This increased capacity is fueled by rapid growth in processing capacity. But, more compact capacity means higher heat densities. What was a 1 kW rack now may exceed 10 kW. This requires a shift in focus from a room-based view of cooling to a rack-based view. More literally, business continuity professionals must consider both "Watt per square foot" and "kW per rack" when evaluating cooling solutions.

No Relief in Sight: Heat Loads Rising

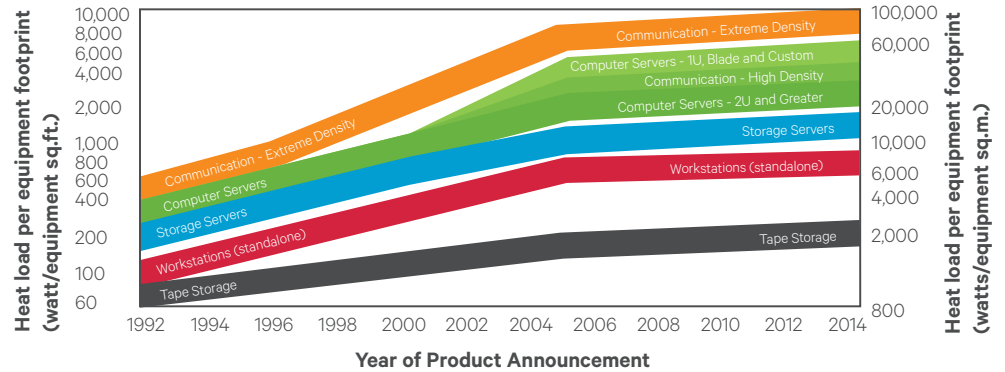

ASHRAE, *Datacom Equipment Power Trends and Cooling Applications*, 2005. © American Society of Heating, Refrigerating and Air-Conditioning Engineers, Inc., www.ashrae.org

And, They Attack Your Facility in Two Ways

Hotter Facilities

As processor capabilities increase, so do computer room power densities— from 50 Watt per square foot (540W/m²) to over 300 Watt per square foot (320W/m²). Your whole data center just keeps getting hotter.

Hot Spots

Compounding the problem, this higher heat load is not evenly distributed throughout the room. Sometimes, power densities can grow into hundreds of Watt per square foot, creating localized "hot spots" of extreme heat.

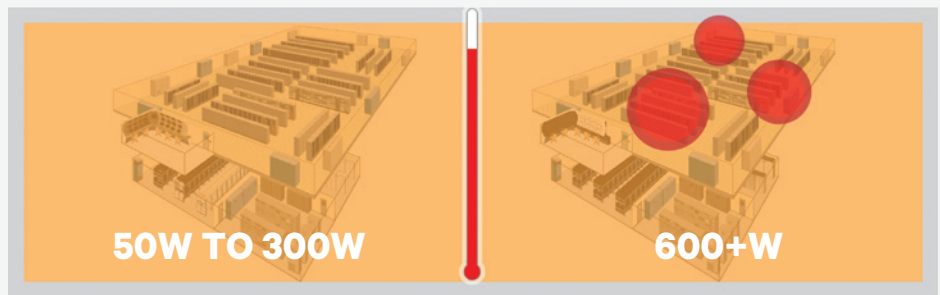

The Cold Aisle Is Feeling A Bit Hot

A common way to improve performance of existing raised floor cooling applications has been the “hot aisle/cold aisle” approach. In this configuration, rows of equipment racks are arranged in alternating “hot” and “cold” aisles. Only the cold aisles have perforated floor tiles that allow cool air to come up from under the raised floor.

Unfortunately, even when using a hot aisle/cold aisle configuration, the limits of standard underfloor cooling are soon reached as rack heat loads increase.

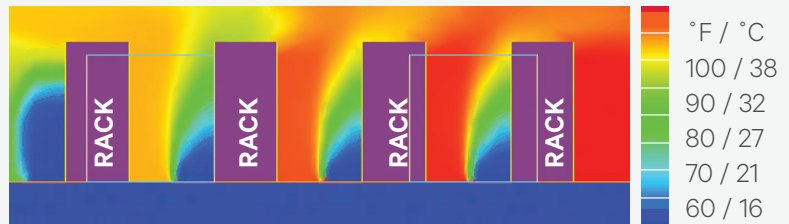

Heat Load = 3 kW Per Rack With Hot Aisle /Cold Aisle Layout

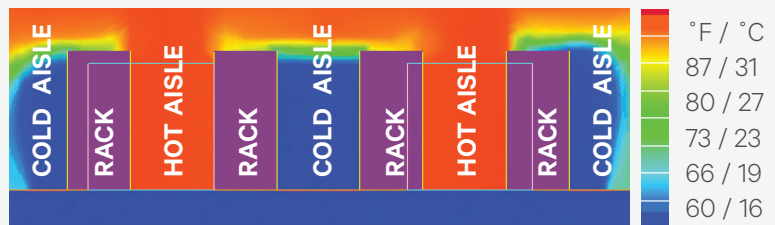

Heat Load = 3 kW Per Rack With Hot Aisle /Cold Aisle Layout

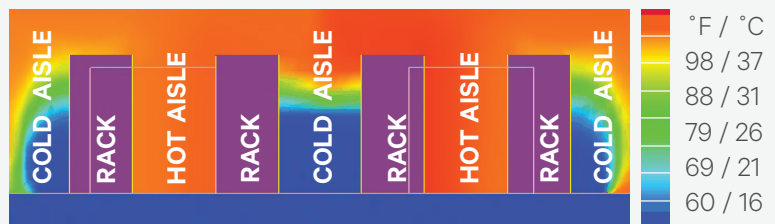

Heat Load = 6 kW Per Rack With Hot Aisle /Cold Aisle Layout

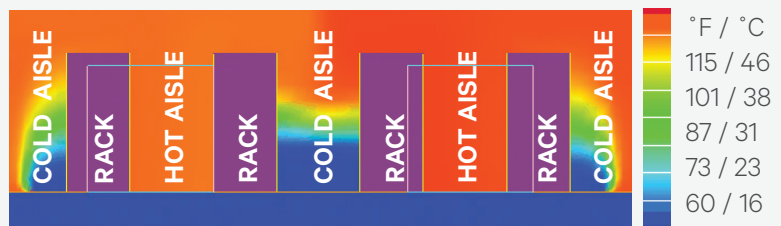

Heat Load = 10 kW Per Rack With Hot Aisle /Cold Aisle Layout

Side views of Computational Fluid Dynamics (CFD) by Fluent showing limitations of hot aisle/cold aisle approach as heat load increases.

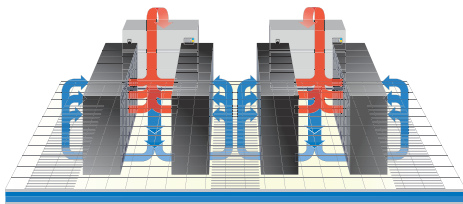

LIEBERT® XD™: THE FLEXIBLE SOLUTION

Business continuity professionals are demanding an integrated high heat density cooling solution – one that considers both room-level and rack-level needs.

Effective Solutions Need to be Flexible

The Liebert XD solution for high heat density cooling applications can be implemented as a hybrid approach using a combination of floor-mount mission-critical cooling units and cooling from the Liebert XD Series as supplemental or primary.

Added as heat loads increase, the Liebert XD cooling capacity allows your facility to adapt as heat loads rise — allowing cooling solutions to be added and reconfigured to react to the changes in your environment.

Flexible Approaches For High Heat Density Cooling

No one offers you more ways to meet the challenges of cooling high heat density installations than Liebert®. We offer open and closed architectures and the widest range of equipment configurations to meet every need.

Adding targeted cooling is more cost-efficient than trying to lower the temperature of localized hot spots by increasing the overall room air conditioning capacity. Liebert X-treme Density mission-critical cooling systems are specifically designed to address the higher heat loads generated by tightly packed electronic rack enclosures. Individual systems can improve interior air flow, cool hot air ejected from the enclosure or cool hot spots near the racks.

Open and Closed Architecture Systems as defined by ASHRAE

The open architecture systems utilize cooling coils near the heat load either inside or outside the open server rack and utilize the room air volume as a thermal storage to ride through short power outages.

The closed architecture fully encloses the rack with the cooling coils inside. Other provisions are required for power loss ride through.

Liebert XD Pumped Refrigerant-Based Systems

Pumped refrigerant is ideal for use in data center environments. By eliminating the use of cooling water, it removes the chance of electrical hazards. It operates at low pressure and becomes a gas at room temperatures, making it ideal for use around electronic equipment.

Liebert XD modules utilize micro-channel coil efficiency and low pressure drop for lower operating costs. Use of pumped refrigerant also saves space with smaller piping requirements and the ability to utilize more compact heat exchangers.

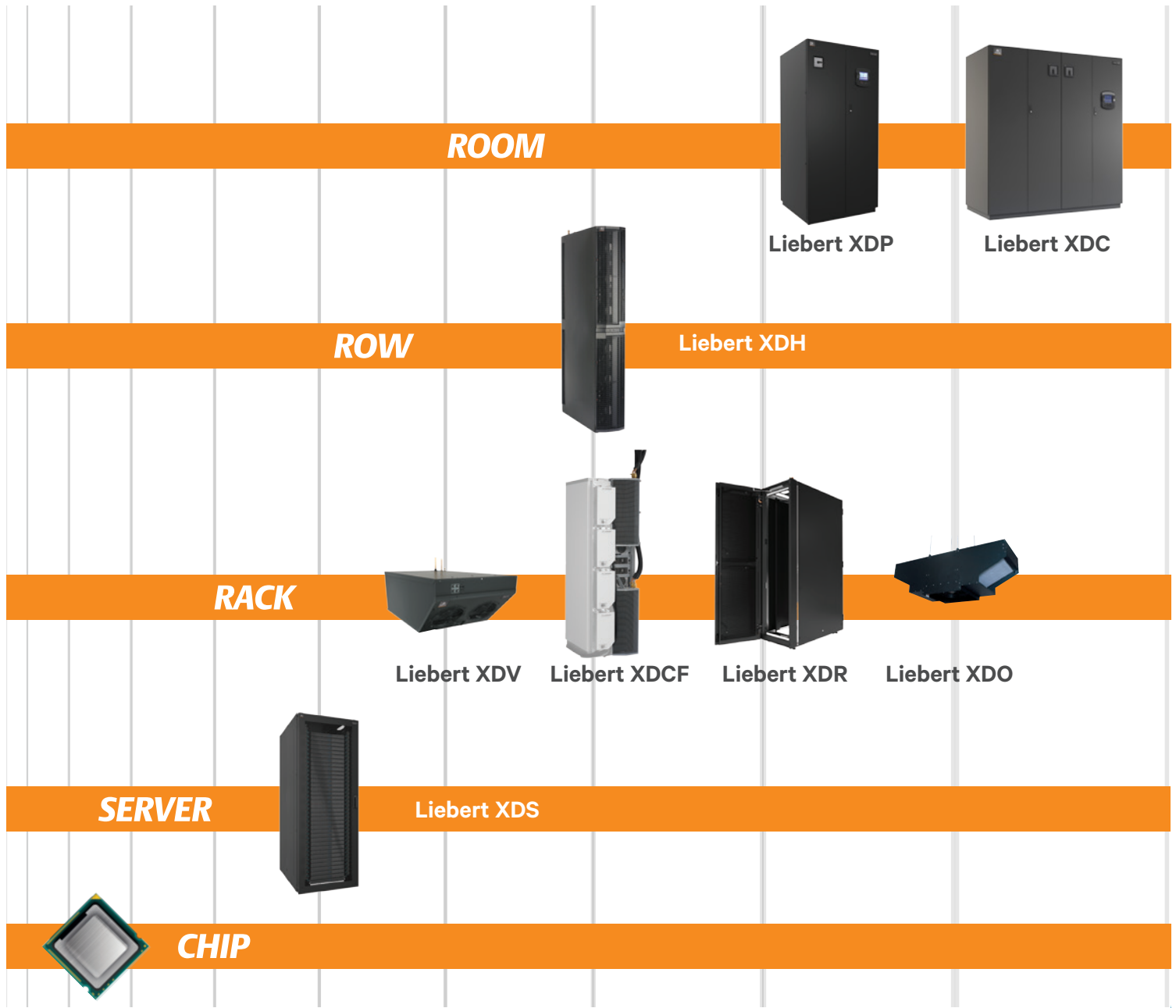

The Liebert XD Piping System makes it easy to plan and expand your Liebert XD Cooling System in response to a growing heat load. The key is to put the necessary piping in place in advance and then add cooling units, chillers or pumping units as the need arises for more cooling capability. The flexible connection piping allows the cooling modules to be added or repositioned without interruption in operation as needs change

Liebert® XD™ Cooling Solutions

The Liebert XD Solution Starts With An Innovative Pumped Refrigerant Application

This unique application of an off-the-shelf product makes the Liebert XD solution very energy efficient. Pumping refrigerant as a liquid and allowing it to expand to a gas as it absorbs heat is over seven times as efficient as a single phase fluid (water), saving energy over similar water-based approaches. The pumped refrigerant operates at low pressure and becomes a gas at room temperatures, making it ideal for use around electronic equipment.

Configurations To Match Data Center Needs

Liebert XD solutions available are modular and expandable to meet the needs of growing and changing data centers. The Liebert XDC or Liebert XDP pumping units support various configurations of Liebert XD cooling modules that cool high density rack loads. Simply mix and match the Liebert XD modules that best suit the room layout and heat load. The cooling modules require little or no additional floor space.



No Building Chilled Water Available...

The **Liebert XDC Chiller is a specially designed indoor** unit that connects directly to the Liebert XD Cooling Modules and provides chilled pumped refrigerant circulation and control. It ensures that the refrigerant is constantly above the actual dew point in the room, eliminating concern about condensation. Available with several heat rejection options.

Building Chilled Water Available...

The **Liebert XDP Pumping Unit serves as an isolating interface** between the building chilled water system and the pumped refrigerant circuit. It circulates refrigerant to the XD Cooling Modules at a temperature always above the actual dew point to prevent condensation.



Liebert® XD™ & Liebert iCOM™

The Liebert iCOM control system on the Liebert XDP and the Liebert XDC unit features:

- Maintenance history
- Spare parts list
- Liebert IntelliSlot® for up to two cards (web compatibility and BMS), and comprehensive monitoring

Utilizing a controller-area network (CANbus) along with the Liebert iCOM control system the Liebert XDC and Liebert XDP bridges a datacenter's building management system (BMS) to Liebert XD Smart Module level.

The enhanced Liebert iCOM with its IT-focused user interface allows:

- Real-time monitoring and data capture of supply and return air temperatures at the rack level
- Module cooling capacity and fan status
- Status to be reported back to the BMS via Liebert IntelliSlot communications cards

An optional refrigerant level sensor sends an alarm when there is a shift in refrigerant level, and sends the alarm to the Liebert iCOM control. This alarm can then be sent the BMS via the Liebert IntelliSlot communication cards.

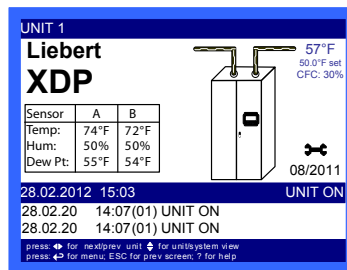

Liebert XDC and Liebert XDP operate with Liebert iCOM controls to maximize the energy efficiency and precision of the system.

Liebert® XD™ Smart Modules

What is a Smart Module?

Smart Modules are a technology option that increases the control and management capabilities of Liebert XD modules. The network bridges the datacenter's building management system to the Liebert Smart Module level.

Liebert XDO, Liebert XDV and Liebert XDH. Smart Modules provide the following capabilities and information back to the Liebert XDC or Liebert XDP with iCOM :

- Monitor fan status locally at the module
- Alert to the presence of condensation
- Remotely shutdown the module via CANbus
- Save energy by adjusting the number of fans operating in multi-fan modules
- Provides Module Cooling Capacity
- Module Supply and Return Air Temperatures
- Module Supply Refrigerant Temperature

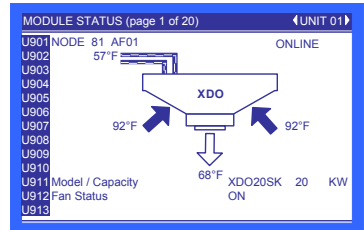
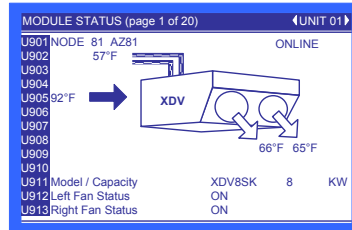
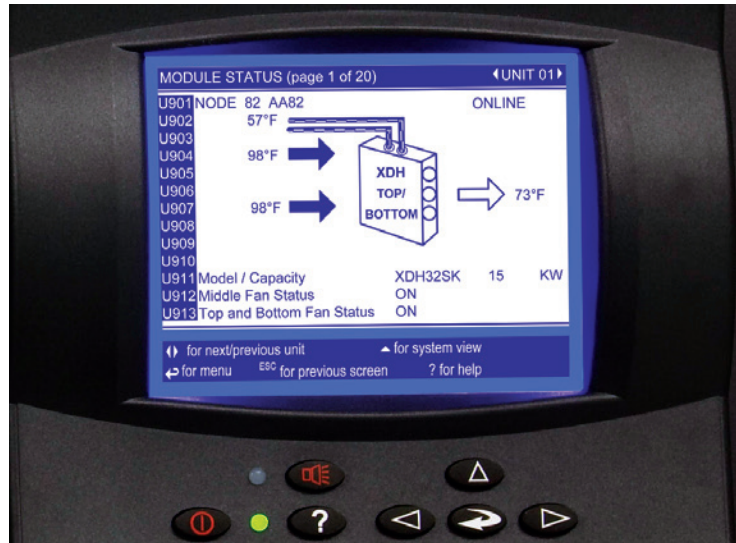

Stay informed: Status of connected SmartModules is graphically displayed on the Liebert iCOM control of the supporting Liebert XDC or Liebert XDP.

Smart Module Operation

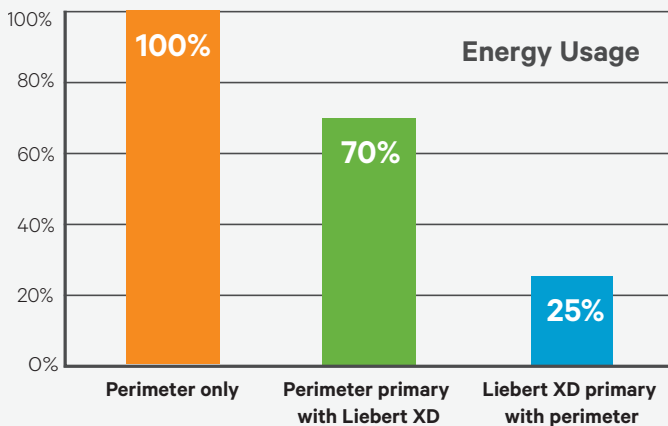

More Energy Savings!

The traditional deployment of the Liebert XD system is as a supplement cooling solution, which can save more than half of the energy to cool the data center. By allowing the fans to cycle based on the temperature, the smart modules can save additional energy savings.

Liebert® XD™ Cooling Modules

The Overhead Cooling Solution

The ceiling-mounted **Liebert XDO overhead cooling module** mounts directly above the cold aisle. It draws in hot air from the hot aisle and then discharges cool air into the cold aisle where the equipment air inlets are located. This energy-efficient unit takes up no floor space. Available with Smart Module integrated control board, for increased module control and monitoring.



**SMART
MODULE**

Space-Saving Solution That Cools From The Top

The **Liebert XDV cooling module** **mounts vertically** above or on the IT rack enclosure, drawing hot air from inside the cabinet or from the hot aisle. It then cools the air and discharges it down to the cold aisle. This space-saving solution requires zero floor space. Available with Smart Module integrated control board, for increased module control and monitoring.



**SMART
MODULE**

Row-based Cooling That's Right In Line With Your Needs

The modular **Liebert XDH horizontal row cooler** is placed **directly in line** with rack enclosures. Air from the hot aisle is drawn in through the rear of the unit, cooled, and then discharged through the front of the unit into the cold aisle. The modular and adaptive design of the Liebert XDH allows it to be easily added as the demand for cooling increases. Available with Smart Module integrated control board, for increased module control and monitoring.



**SMART
MODULE**

High Heat Density Cooling in a Space-Saving Design

Liebert XDR rack door cooling module replaces the back door of a server enclosure, providing cooling without increasing the rack footprint. The module uses the server fans within the protected rack to provide airflow, providing an extremely energy efficient design.



The Most Energy Efficient Cooling Available

The **Liebert XDS module** is the newest and most energy efficient addition to the Liebert XD System. Using integrated Direct Heat Transfer™ (DHT™), Liebert XDS maximizes energy efficiency by operating without cooling system fans or server fans. This unique solution saves up to 80% when compared to traditional air cooling – even more efficient than traditional systems that use air economizers.



A Specialized Rack Cooling Solution

Liebert XD CoolFrame™ module is specially designed to attach directly to the rear of the Egenera BladeFrame EX system. The Liebert XD CoolFrame allows these racks to be placed in a data center environment around other heat-generating equipment without adding to the heat load in the room. Use of the Liebert XD CoolFrame solution can promote efficient expansion of data center capacity with a minimal impact on your critical infrastructure.



Liebert® XDO Overhead Cooling Module

The ceiling mounted Liebert XDO overhead cooling module provides sensible spot and zone cooling for high heat density equipment.

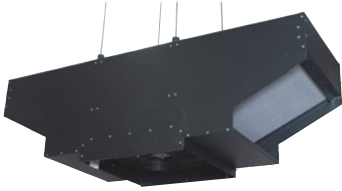

Features:

- Can cool more than 500 W/sq.ft. (5400 W/m²)
- No floor space required
- Excellent for spot and zone cooling
- Scalable
- Flexible installation with several connection possibilities
- Optional pre-charged flexible piping with threaded quick-connect fittings allows adaptive and scalable expansion without interruption of cooling operations
- Possible to be fully installed from an existing cold aisle without the need for reaching over existing racks
- Compatible with Liebert XDP, Liebert XDP with iCOM and Liebert XDC systems

The Liebert XDO draws in hot air through two opposite inlets and discharges cool air down into the cold aisle where the electronic equipment air inlets are located. This flexible, scalable and space saving product mounts to the ceiling — requiring zero floor space.

The Liebert XDO is a part of our high heat-density cooling product family that utilizes pumped refrigerant technology. The pumped refrigerant operates at low pressure in the system and becomes a gas at room conditions, making it ideal for use around electronic equipment. Since the Liebert XDO always provides 100% sensible capacity, the need for humidification is significantly reduced, further reducing energy usage and maintenance.

Specifications - Liebert XDO

	XDO16	XDO20
Nominal Capacity, 60 Hz¹	17.2 kW / 5 Ton	20 kW / 5.7 Ton
Nominal Capacity, 50 Hz¹	17.1 kW / 4.9 Ton	17.7 kW / 5 Ton
Nominal Airflow, 60Hz	2700 CFM (4590 m ³ /h)	
Nominal Airflow, 50Hz	2250 CFM (3820 m ³ /h)	
Input Voltage	120 V, 1 ph, 60 Hz 220-240 V, 1 ph, 50/60 Hz	
Full load amps	2.7A @ 120V, 1ph, 60 Hz 1.5A @ 230V, 1ph, 50 Hz	
Audible Noise, 60 Hz/50 Hz	85 dBa / 83 dBa Sound Power	
Height, module only	22.5" (572 mm)	
Width	72.0" (1829 mm)	
Depth	24" (610 mm)	
Weight, empty	150 lbs (68 kg)	
Options	Smart Module Control Board (Includes Condensate Detection) Quick Connect Couplings (for Flexible Piping)	

¹ Nominal Capacity Rating is @ 55°F (13°C) Entering Fluid Temperature and 92°F (33°C) Entering Air Temperature.
Max capacity 60Hz: XDO16 - 17.2kW @ 90°F (32°C), XDO20 - 23kW @ 100°F (38°C)
Max capacity 50Hz: XDO16 - 17.2kW @ 93°F (34°C), XDO20 - 23kW @ 103°F (39°C)

SMART MODULE AVAILABLE

Liebert® XDV Vertical Top Cooling Module

The Liebert XDV top-mounted cooling module provides sensible spot and zone cooling for high heat density equipment.



This flexible, scalable and space saving product mounts on top of the cabinet or suspended from the ceiling, requiring zero floor space. The modular and adaptive design of the Liebert XDV unit also allows it to be easily added as the demand for cooling increases.

It can either draw in hot air directly from inside the cabinet or from the hot aisle, and discharge cool air down into the cold aisle where the electronic equipment air inlets are located.

The Liebert XDV is a part of our high heat-density cooling product family that utilizes pumped refrigerant technology. The pumped refrigerant operates at low pressure in the system and becomes a gas at room conditions, making it ideal for use around electronic equipment. Since the Liebert XD system always provides 100% sensible capacity, the need for humidification is significantly reduced, further reducing energy usage and maintenance.

SMART MODULE AVAILABLE

Features:

- Scalable
- Can cool more than 10 kW per rack
- No floor space required
- Optional pre-charged flexible piping with threaded quick connect fitting allows adaptive and scalable expansion without interruption of cooling operations
- Flexible installation — mounts on top of the cabinet or suspended from the ceiling
- Excellent for spot and zone cooling
- Compatible with Liebert XDP, Liebert XDP with iCOM and Liebert XDC systems
- Dual (A and B) detachable power cords for increased uptime

Specifications - Liebert XDV

	XDV8	XDV10
Nominal Capacity, 60 Hz¹	8.8 kW / 2.5 Ton	10 kW / 2.8 Ton
Nominal Capacity, 50 Hz¹	8 kW / 2.3 Ton	8 kW / 2.3 Ton
Nominal Airflow, 60Hz	1000 CFM (1700 m ³ /h)	
Nominal Airflow, 50Hz	830 CFM (1410 m ³ /h)	
Input Voltage	120 V, 1 ph, 60 Hz 230 V, 1 ph, 50/60 Hz	
Full load amps	2A @ 120V, 1ph, 60 Hz 1A @ 230V, 1ph, 50 Hz	
Audible Noise, 60 Hz / 50 Hz	78 dBa / 73 dBa Sound Power	
Height, module only	14" (355 mm)	
Width	23" (581 mm)	
Depth	29.5"-39.5" (749-1003 mm)	
Weight, empty	77 lbs (35 kg)	
Options	Quick Connect Couplings (for Flexible Piping) Smart Module Control Board (Includes Condensate Detection)	

¹ Nominal Capacity Rating is @ 55°F (13°C) Entering Fluid Temperature and 98°F (37°C) Entering Air Temperature.
Max capacity 60Hz: XDV8 - 8.8kW @ 95°F (35°C), XDV10 - 11.8kW @ 106°F (41°C)
Max capacity 50Hz: XDV8 - 8.8kW @ 103°F (39°C), XDV10 - 11.8kW @ 116°F (47°C)

Liebert® XDH Horizontal Row Cooling Module

The modular, Liebert XDH horizontal row cooler provides efficient and economical cooling for high heat density equipment. The Liebert XDH is placed in line with rack enclosures and air from the hot aisle is drawn in through the rear of the unit, cooled, and discharged into the cold aisle where the electronic equipment air inlets are located. The Liebert XDH draws directly from the hot aisle, allowing the unit to take advantage of higher heat transfer efficiency.



Features:

- Scalable
- Can cool more than 30 kW per rack
- Optional pre-charged flexible piping with threaded quick connect fittings allows adaptive and scalable expansion without interruption of cooling operations
- Flexible installation
- Complete packaged unit includes enclosure, coils, controls, fans and piping
- Compatible with Liebert XDP, Liebert XDP with iCOM and Liebert XDC systems
- Dual (A and B) detachable power cords for increased uptime
- Two pumped refrigerant circuits

The Liebert XDH is a part of our high heat-density cooling product family that utilizes pumped refrigerant technology. The pumped refrigerant operates at low pressure in the system and becomes a gas at room conditions, making it ideal for use around electronic equipment.

Since the Liebert XD system always provides 100% sensible capacity, the need for humidification is significantly reduced, further reducing energy usage and maintenance. The modular and adaptive design of the Liebert XDH unit also allows it to be easily added as the demand for cooling increases.

SMART MODULE AVAILABLE

Specifications - Liebert XDH

	XDH20	XDH32
Nominal Capacity, 60 Hz¹	22 kW / 6.3 Ton	30 kW / 8.5 Ton
Nominal Capacity, 50 Hz²	19 kW / 5.4 Ton	27 kW / 7.7 Ton
Nominal Airflow, 60 Hz	2500 CFM (4200 m ³ /h)	4000 CFM (6800 m ³ /h)
Nominal Airflow, 50 Hz	2100 CFM (3500 m ³ /h)	3300 CFM (5600 m ³ /h)
Input Voltage	120 V, 1 ph, 60 Hz 230 V, 1 ph, 50 Hz	
Power Draw	500 W	1200 W
Full load amps	4.2 A @ 120V	10.5 A @ 120V
Number of Fans	6	
Sound Power Level	81 dBA	86 dBA
Height (unit only)	78" (1982 mm)	
Width	12" (300 mm)	
Depth	42" (1066 mm)	
Weight	246 lbs (112 kg)	
Options	Quick Connect Couplings (for Flexible Piping) Smart Module Control Board (Includes Condensate Detection) Diffuser for front air discharge to both sides or to one side.	

¹ Nominal Capacity Rating @ 55°F (13°C) Entering Fluid Temperature and 98°F (37°C) Entering Air Temperature.
Max Capacity @ 55°F (13°C) EFT and 105°F (40°C) EAT is 25.5 kW and 34.5 kW, respectively.

² Nominal Capacity Rating @ 55°F (13°C) Entering Fluid Temperature and 98°F (37°C) Entering Air Temperature.
Max Capacity @ 55°F (13°C) EFT and 116°F (47°C) EAT is 25.5 kW for XDH20 and 34.5 kW @ 108°F (42°C) EAT for XDH32.

Liebert® XDR Rack Door Cooling Module

The Liebert XDR is a fanless heat exchanger module that installs as the rear door of an equipment rack, providing up to 20kW of room neutral cooling.



The Liebert XDR design uses the server fans within the protected rack to provide airflow through the unit. The microchannel coil heat exchanger cools the air and returns it to room at close to the same temperature as the air entering the rack.

The open design of the microchannel allows the Liebert XDR to mimic the airflow of a perforated door, a feature that literally can be seen.

The Liebert XDR is a part of the Liebert XD high heat density cooling system that utilizes pumped refrigerant technology. The pumped refrigerant operates at low pressure in the system and becomes a gas at room conditions, making it ideal for use around electronic equipment. Since the Liebert XDR always provides 100% sensible capacity, the need for computer room air conditioners to provide humidification is significantly reduced, resulting in lower energy usage.

Features:

- Replaces the existing back door on IT racks from Vertiv™ and other major manufacturers
- Requires minimal floor space
- Door allows for full access to the servers and equipment by opening greater than 100 degrees
- Supports both hot aisle/cold aisle configurations and irregular configurations
- Allows adaptive and scalable expansion without interruption of cooling operations
- Operates with the Liebert XD family as a part of a high density cooling solution
- Operates with high energy efficiency – no fans or moving parts requiring electricity
- Fanless cooling module requires no maintenance

Ideally Suited For:

- Rack heat loads up to 20kW
- Vertiv and other equipment enclosure racks
- Existing XD systems supported by Liebert XDP and Liebert XDC
- Hot spots, regardless of space configuration

Specifications - Liebert XDR

Nominal Capacity, 60 Hz	20.5 kW / 5.8 Ton
Nominal Capacity, 50 Hz	20.5 kW / 5.8 Ton
Physical	*Height : 78.4 (1992 mm)
*Height without piping connections	Width 23.5" (597 mm)
	Depth 5.9" (150 mm)
	Weight, empty 130 lbs (59 kg)
Piping	Hard-piping, Quick-connect couplings (Removable and "One-Shot") for Flexible Piping
Rack Compatibility	24" x 42U (600mm x 42U) rack enclosure
Maximum modules per loop	8 (eight)

Nominal Capacity Rating is @ 55°F (13°C) Entering Fluid Temperature and 104°F (40°C) Entering Air Temperature, 2400 CFM (68 m³/min)

Liebert® XDS Server Cooling Module

The innovative Liebert XDS is the newest and most energy efficient addition to the Liebert XD System. Using integrated Direct Heat Transfer™ (DHT™), Liebert XDS maximizes energy efficiency by operating without cooling system fans or server fans. This unique solution saves up to 80% when compared to traditional air cooling –even more efficient than traditional systems that use air economizers.

Features:

- Removes up to 600W per 1U slot, for a total of more than 20kW per rack
- Racks can be deployed on raised floor or a slab
- Silent operation allows placement in sound-sensitive environments
- Eliminates the requirement for server fans, removing one of the largest sources of server component failure
- Removal of cooling fans and server fans provides an 80% energy savings over traditional cooling methods
- Can operate at elevated chilled water temperatures, allowing additional energy savings to be realized by maximizing the use of water economization

Ideally Suited For:

- Greenfield applications for new datacenters
- Brownfield retrofits for existing datacenters
- Applications requiring highly efficient cooling of dense supercomputing applications
- Applications where reduced acoustic footprint is desirable

Specifications - Liebert XDS

Nominal Cooling Capacity	20kW
Coolant Pumping Unit	Liebert XDP or Liebert XDC, 160kW
Rack Standard	Based on EIA-310-D, EIA-310-E
Server Bays	Qty. 35 –1U for the 42U Rack Qty. 36 –1U for the 45U Rack
Height	78.75 in(2000mm); 84.0 in (2134mm)
Width	31.5 in (800mm)
Depth	39.4 in (1000mm); 43.3in (1100mm); 47.0 in (1200mm)
Height per Bay (1U)	1.75 in (44.45mm)
Internal Width	19 in (483mm)
Internal Depth	29.0 in (736.6mm) or 26.0 in (660.4mm)
Cabinet Style	Free Standing
NEMA Rating	Non-Hazardous Locations Hazardous Locations
Ingress Protection (IP) Type	Protection Against Foreign Objects
Doors	Optional lockable front & rear doors
Side panels	Optional
Construction Material	Aluminum Frame, Powder Coated Steel Sheet Metal and Copper Plumbing
Leveling Feet	Supplied
Rack Hole Type	#10/32 threaded
Coolant Connection Type:	
Refrigerant ingress connection	½" Seal-Lok (male)
Refrigerant egress connection	1" Seal-Lok (male)



Data Center Cooling Power in Chicago

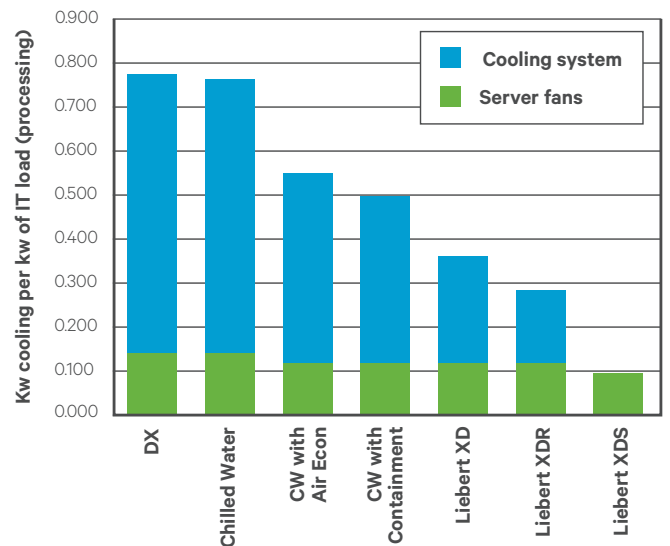

The cooling system portion contains the following as applicable:
Liebert XD modules, Liebert XDP, CRAH fans, Humidification control, Cooling Tower kW, Chiller Pumps kW, and Chiller/DX unit.

Liebert® XD™ CoolFrame

Working Together To Meet The Challenges Of Today's Data Centers



Features:

- Maintains all BladeFrame functionality — BladeFrame EX renowned serviceability features are unaffected. Efficient cable management is preserved
- Easy to install — Simple mechanical attachment to the BladeFrame EX
- Everything you need — No additional air movers are required for the BladeFrame EX system. No additional power is required for Liebert XD CoolFrame
- Saves on cooling costs — Saves 23% of typical data center cooling energy cost
- Takes up no additional floor space — BladeFrame EX retains same footprint, even with the Liebert XD CoolFrame modules attached

Egenera and Liebert have recognized that many customers are concerned with rising heat loads in their facilities and wanted to provide a flexible, cost-effective solution to reduce the stress on existing cooling systems as additional computing capacity is installed.

The Liebert XD CoolFrame allows the BladeFrame EX to be placed in a data center environment around other heat-generating equipment without adding to the heat load in the room. Use of the Liebert XD CoolFrame also enables users to place more BladeFrame EX systems into the data center than would otherwise be possible without it.

Specifications - Liebert XD CoolFrame

Compatibility

PRODUCT	MODEL NUMBER
Egenera BladeFrame EX	BC 100101, BC 100102
Liebert XD CoolFrame Module	XD-CF-10-XX
Liebert XDP	XDP160RXXXX
Liebert XDC	XDC160AXXXX
Liebert XD Field Piping Kits and Liebert XD Connection Port Kits	

Technical Data Liebert XD CoolFrame Module

Nominal Capacity	10 kW (2.8 tons)
Height	30-1/4" (768mm)
Width	12-1/4" (311mm)
Depth	6-1/2" (165mm)
Weight, empty	18 lbs (8kg)
Flex-Pipe Length	Top Module 6' (1.8m) Bottom Module 10' (3m)
Nominal Capacity	160 kW (46 Ton), 60Hz 140 kW (40 Ton), 50Hz
Height x Width x Depth	76"x37"x30" (1930mm x 940mm x 762mm)
Minimum Number of Liebert XD CoolFrame modules	4

Liebert® XD™ Piping: The Key to Adapatibility

The Liebert XD Piping system makes it easy to plan and expand your Liebert XD Cooling system in response to a growing heat load.

The key is to put the necessary piping in place in advance and then add cooling units and pump units/chillers as the need arises for more cooling capability.

This unique system allows the room cooling capacity to increase to more than 30 kW per rack with no additional disruptive piping installation. The flexible connection piping also allows the cooling modules to be re-positioned without interruption in operation.

Invest Now, Save In The Future

Liebert XD Piping provides for future expansion and simplifies both the installation of additional units and the reconfiguration of components as needs change.

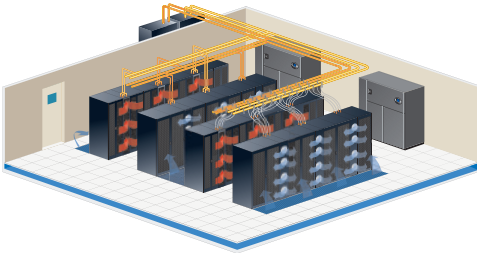

Liebert XD Piping is pre-fabricated distribution piping that is installed in anticipation of a growing system, then Liebert XD Cooling modules are added, disconnected, or repositioned as required and are quickly made operational with flexible connection piping with quick-connect fittings.

These computer room layouts illustrate how growth can be accommodated within the same space by installing additional Liebert XD Cooling capacity.

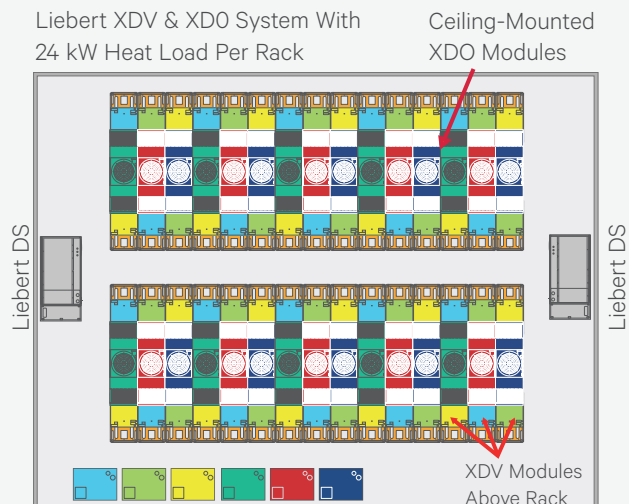
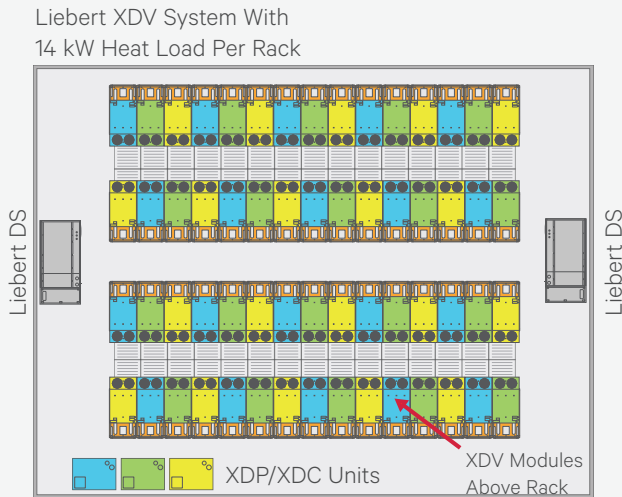
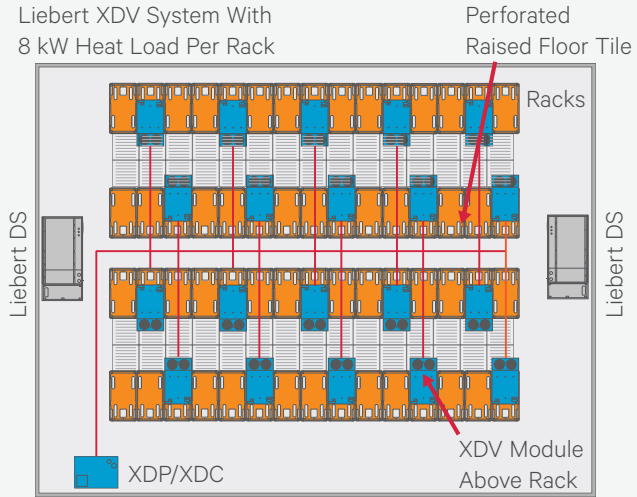

Service Solutions

Programs To Keep You Up and Running

Vertiv™ offers more ways to handle your Liebert® precision cooling maintenance and emergency service requirements than any other source. Service and support specialists are located everywhere you need them to be.

The Best Coverage In The Business

Field service is provided by Vertiv Services technicians augmented with The Service Partner Network — a nationwide network of locally-based service partners, with factory-trained technicians that handle service support and maintenance of Liebert precision cooling products. Warranty inspection at the time of start-up by these technicians can ensure proper operation and tune the performance of the unit to the application. This can be instrumental in assuring a long unit life.

The variety of service offerings includes warranty service, emergency service, preventive maintenance and professional services. We offer 24 x 7 x 365 emergency dispatch service through our Customer Resolution Center. This facility provides immediate access to factory-trained technicians, located within your own area, who are quickly dispatched to your location when service is required. Preventive maintenance solutions provide you with a choice of coverage options — each designed to meet your specific

support requirements. These offerings are ideal for those who require the peak operating efficiency, reliability and uptime that only a comprehensive maintenance program can deliver.

We also offer a site management program that creates a customized service package for your operation by offering a single point of contact for all your service needs. It gives you a proactive action plan to provide operational support and guidance for your critical facility.

Additional Service Offerings That Make A Difference

Liebert Services can also help to improve your data center performance and energy efficiency.

- Enterprise remote monitoring
- Liebert iCOM™ controls networking/upgrading
- Thermal assessments and CFD modeling
- Energy efficiency assessments

Remote Monitoring

Enhance your data center reliability and visibility with comprehensive alarm management, diagnostics and response services that are tailored to your specific needs. For both flexibility and reliability, we can monitor via the Web or through dial-up. By using network interface cards, we provide significantly more alarm types for diagnostics. And our Customer Resolution Center is ready to respond as soon as an alarm occurs.

Our ability to poll your equipment's operational data at regular intervals provides unsurpassed predictive maintenance capabilities. Certified technicians analyze your data, identifying issues before they become problems and maximizing availability.



VertivCo.com | Vertiv Headquarters, 1050 Dearborn Drive, Columbus, OH, 43085, USA

© 2016 Vertiv Co. All rights reserved. Vertiv and the Vertiv logo are trademarks or registered trademarks of Vertiv Co. All other names and logos referred to are trade names, trademarks or registered trademarks of their respective owners. While every precaution has been taken to ensure accuracy and completeness herein, Vertiv Co. assumes no responsibility, and disclaims all liability, for damages resulting from use of this information or for any errors or omissions. Specifications are subject to change without notice.